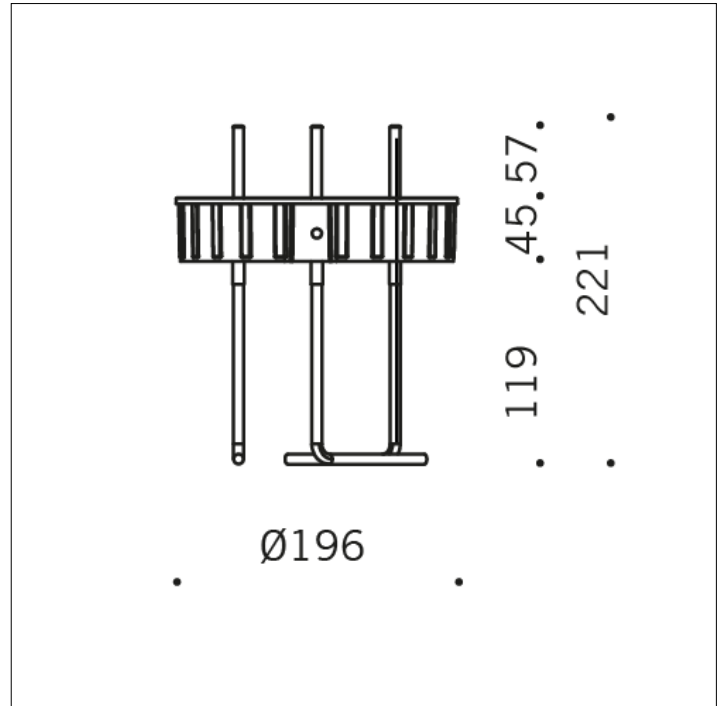

ACCESSORY

**S.4171
FLANGE**

Flange $\text{Ø} 195\text{mm}$ h 165mm to be fixed in concrete with stainless steel screws for fixing in the ground. Footstall dimension can be calculated according to your country norms and ground properties.