

ACCESSORY

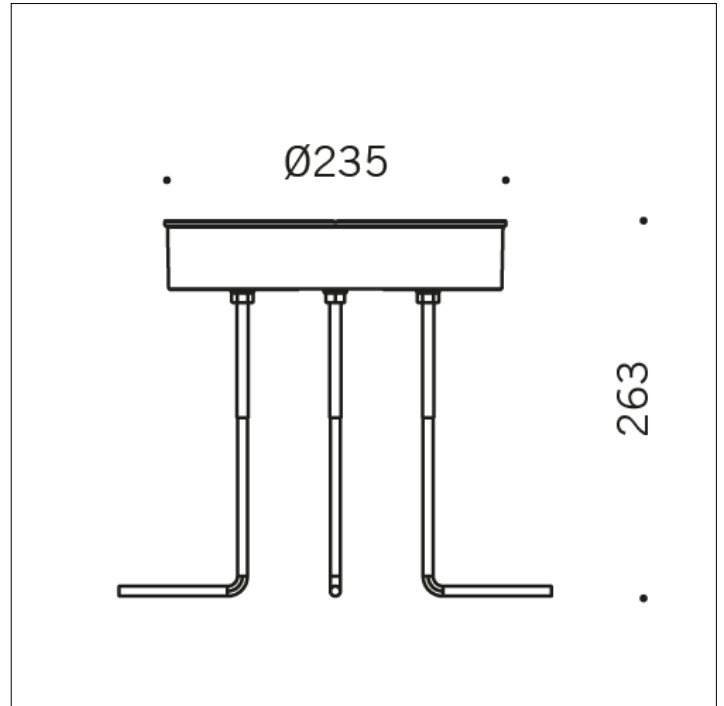

S.5690
ANCHOR FLANGE TO BE CEMENTED TO THE
GROUND

For applications in driveways areas, the luminaires must be installed with its proper anchor flange. The flange is provided with the necessary fixing A4 screws in stainless steel.